



**ORANGE
PAVERS**

catalog



Your vision. Our Pavers

Pavers & Slabs | Retaining walls | Blocks

orangepavers.com



YOUR GO-TO GUIDE FOR SELECTING COLORS
AND MATERIALS FOR YOUR BACKYARD

Lunar Path in Brown

The ultimate guide to selecting colors and materials for your backyard

Contents:

Pages

- 03. About Orange Pavers
- 06. Lifetime Warranty
- 07. Material Guide
- 11. Why choose pavers over asphalt
- 12. Texture options

Pavers & Slabs

- 15. Grande Valley
- 17. Lunar Path
- 19. Arona
- 21. Flint Stone
- 23. Akoya
- 25. Bohemian Buffalo
- 27. Holland Lux

Retaining walls

- 31. Cascade







Blocks

- 35. CMU and Architectural Blocks

Useful information

- 38. Do's and don't when selecting color choices
- 39. Technical information
- 40. Pallet Overview
- 41. Paver foundation
- 44. Patterns
- 45. Getting to know your home
- 47. Commercial & industrial

Legend

- | | |
|--|--|
|  De-icing salt |  Light duty vehicular |
|  Residential / pedestrian |  Heavy vehicle |
|  Commercial |  Accents |

The color options are composed of a range of darker and lighter tones for an authentic look. The natural ingredients in this recipe allow each stone to have a unique tone, veining, and texture. Samples of colors are provided for reference only. Colors of the actual product may differ.

Quality is our top priority

Homeowners, architects, builders, and developers alike turn to us for the best paver products on the East Coast because of our clear objective, years of experience, and a commitment to using traditional worldwide innovation methods.



LOW MAINTENANCE

Using natural and high-quality materials, our pavers are strong, durable, and reliable and require minimal maintenance. No special treatments are required to maintain the overall quality and aesthetics, meaning you get to enjoy your product for years to come without the hassle of maintenance.



AFFORDABLE

By choosing Orange Pavers to complete your next outdoor design with high grade pavers, you are instantly increasing the value of your investment. Rather than paying for expenses of repair, maintenance or replacement with other material options, you also get to enjoy a one time investment for a product that will last a lifetime.



DURABILITY YOU CAN TRUST

Made from a mixture of high quality materials, pavers and slabs are stronger and more durable than other similar product options. Able to withstand even the harshest weather elements, pavers offer peace of mind for any environment.



SUSTAINABILITY

Our goal is to bring customers a finished product that will last forever while caring for the environment. Our process includes using natural resources to create pavers that you can be proud of.



**ORANGE
PAVERS**

Your vision. Our Pavers.



Arona in Pearl river

A lifetime guaranteed style

All **Orange Pavers** products surpass and comply with the current standards established by American Society for Testing and Materials (ASTM). **Orange Pavers** offers a lifetime transferable warranty for residential projects. Starting from the delivery date to the job site that covers the structural integrity of the products and any abnormal deterioration of its surfaces. Registration is required and must be complete within 90 days of your dated proof of purchase.



INSPIRATION

Our company was built on inspiration. In order to help our customers create their dream outdoor living spaces, we love to share that same spirit.

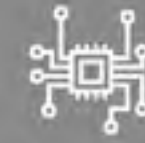

INNOVATION

At Orange Pavers we constantly strive to produce the most advanced product by incorporating the latest and most effective methods and technologies.

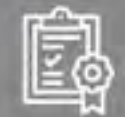

QUALITY

In order to ensure the highest standards for our concrete paver systems, our plants receive annual certification by The Interlocking Concrete Pavement Institute (ICPI).



FOCUS

With a distinctive and customized approach, we embark on each project with enthusiasm and passion to create the desired outdoor living space envisioned by our customer.



EXPERTISE

Renowned for our expertise within the hardscapes industry, we take great pride in our ability to provide others with insights, education, and training.



**ORANGE
PAVERS**

Your satisfaction is our mission and we are with you every step of the way

Here are some common **Do's** and **Don'ts** when selecting material choices

- Visit our showroom and view our product brochures.
- Play with mixing textures and forms (smooth/textured, dark/bright, wide/narrow tiles, etc.).
- Invest in the right material for your specific needs.
- View pavers in sunlight for accuracy.

- Don't commit to any color without viewing it in natural light.
- Don't combine more than three core colors (with the exception of wood and stone).
- The color options are composed of a range of darker and lighter tones for an authentic look. The natural ingredients in this recipe allow each stone to have a unique tone, veining, and texture. Samples of colors are provided for reference only.
- Colors of the actual product may differ.





Grande Valley in Graphite

orangepavers.com

Holland lux in Grey

Why choose pavers



FUNCTIONALITY

Quickly and easily replace single pavers for on-site repairs



ECO-FRIENDLY

No harmful substances are released when heated.



DURABILITY

Water cannot penetrate due to density and lack of air pockets



DESIGN

With our wide array of colors and sizes to choose from, you can create virtually unlimited patterns and styles.

Concrete pavers made from recyclable natural materials are an outstanding example of an eco-friendly patio solution.

Orange Pavers are an eco-friendly choice enabling the enhancement of backyards and driveways, while protecting the environment. Our pavers are made responsibly from recyclable natural materials, require far less fuel quarrying or transporting, look very attractive, and do not emit harmful substances when heated.

Paver material options

Whether you are designing a pathway, patio, driveway, or pool, you'll want to be sure you choose the best material for the project. With pavers, your options include clay, concrete, manufactured porcelain, and more. One of the most cost effective and durable options is concrete pavers. By choosing to use concrete as your paver material, you can enjoy the benefits it offers, including good traction, wide color options, color longevity.

Residential & Commercial

Designed to last. Whether your design requires a rugged environment or a sleek indoor space, we have the commercial grade pavement for you.



Smooth or Textured?

Explore our two collections

Smooth

Colorful with rich monochromatic tones and unique color mix options. A contemporary touch of straight endless lines.

Textured

Cutting stone is an authentic, classic way to express elegance. Raw materials have a charming and noble quality.



LIFETIME TRANSFERABLE WARRANTY

Orange Pavers is backed by exclusive warranty, so you can be confident your investment is in safe hands.

FOUNDED 1998

For over 25 years, Orange Pavers have been leading the way in pavers manufacturing and design in Europe.

GLOBAL EXPERIENCE LOCAL EXPERTISE

New technologies and a modern quality control system have been implemented at the new modern & innovation plant in the USA.

Your vision. Our Pavers.





GRANDE VALLEY

Grande Valley



Available in multiple colors, Grande Valley is a large concrete patio stone perfect for poolside design and backyard landscaping.



In stock

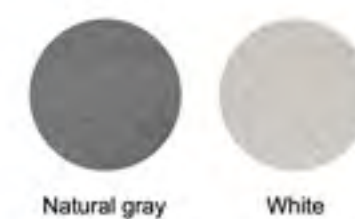

Special Order



16 x 16 x 2 3/8 inches
398 x 398 x 60 mm

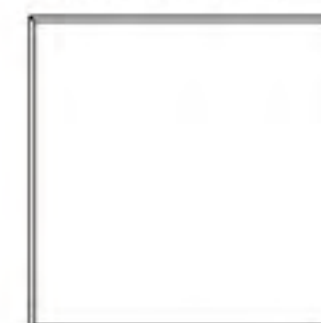



LUNAR PATH

Lunar Path



Whether you're designing a rustic farmhouse or a traditional colonial, Lunar Path's clean lines will add a contemporary touch to any landscape renovation project.

|≡| Smooth

|≡≡| Textured



In stock



Light shadow



White



Black

Special Order



Redwood



Burnt Sienna



Chestnut bay



Cappuccino



Brown



Graphite

24 x 6 x 2 3/8 inches
598 x 148 x 60 mm



|≡| Smooth

|≡≡| Textured





ARONA

Arona (3-piece set)



Having a hard time keeping your poolside clean? Are you looking to upgrade it? It's time to think outside the box! Any exterior space can be made more attractive with our new Arona slabs system. You can express your unique style in your outdoor space through our smooth, modern, and elegant Arona collection.

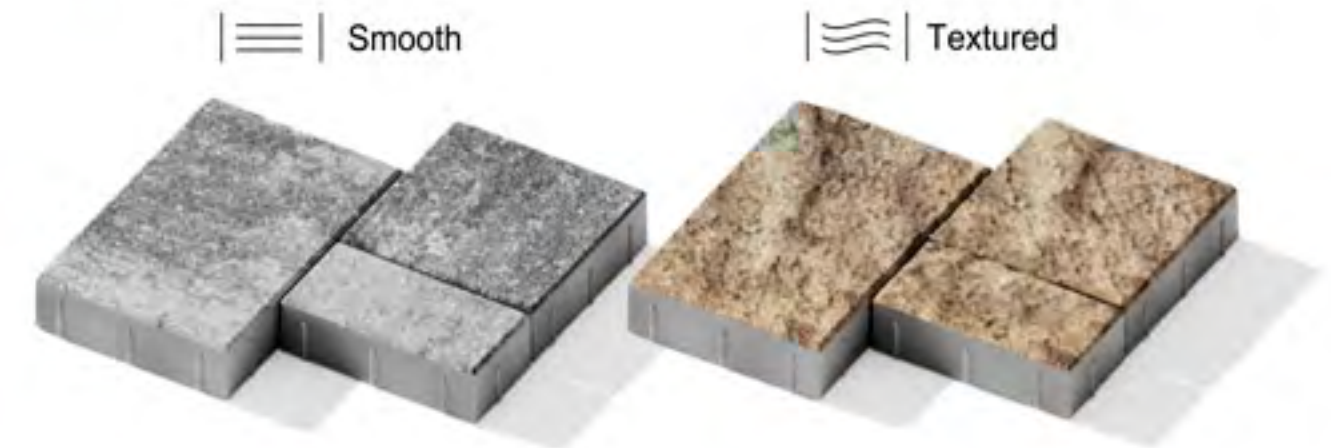

In stock



Special Order



20 x 13 x 2 3/8 inches
506 x 336 x 60 mm



13 x 13 x 2 3/8 inches
336 x 336 x 60 mm



7 x 13 x 2 3/8 inches
166 x 336 x 60 mm



Smooth | Textured





FLINT STONE

Flint Stone



Residential and commercial driveways and patios can benefit from Flint Stone's larger cobblestone look. In order to prevent surface water from percolating into the ground, this interlocking permeable paver was designed to offer appropriate percolation channels, preventing surface water from penetrating into the earth.



In stock



Special Order



9 x 6 x 2 3/8 inches
223 x 148 x 60 mm

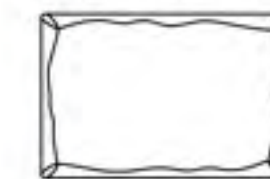

6 x 6 x 2 3/8 inches
148 x 148 x 60 mm

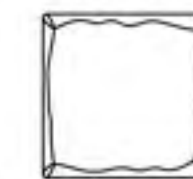

Smooth





AKOYA

Akoya (3-piece set)



An interesting surface texture combines with Akoya penchant for geometric patterns. A modern public park, a plaza, an entertainment square, a sidewalk, or a patio could benefit from the use of this paver. Our smooth technology results in a tighter surface for the most beautiful finishes with higher particles per square inch.



In stock



Chestnut bay Light shadow

Special Order



Redwood Burnt Sienna Cappuccino Brown Graphite White Black



Natural gray

12 x 12 x 2 3/8 inches
298 x 298 x 60 mm



8 x 12 x 2 3/8 inches
198 x 298 x 60 mm



8 x 8 x 2 3/8 inches
198 x 198 x 60 mm

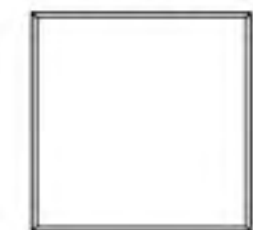

Smooth





BOHEMIAN BUFFALO

Bohemian Buffalo (3-piece set)



The Bohemian Buffalo collection offers a contemporary style with clean lines, a smooth linear surface and striking color blends.



Special Order

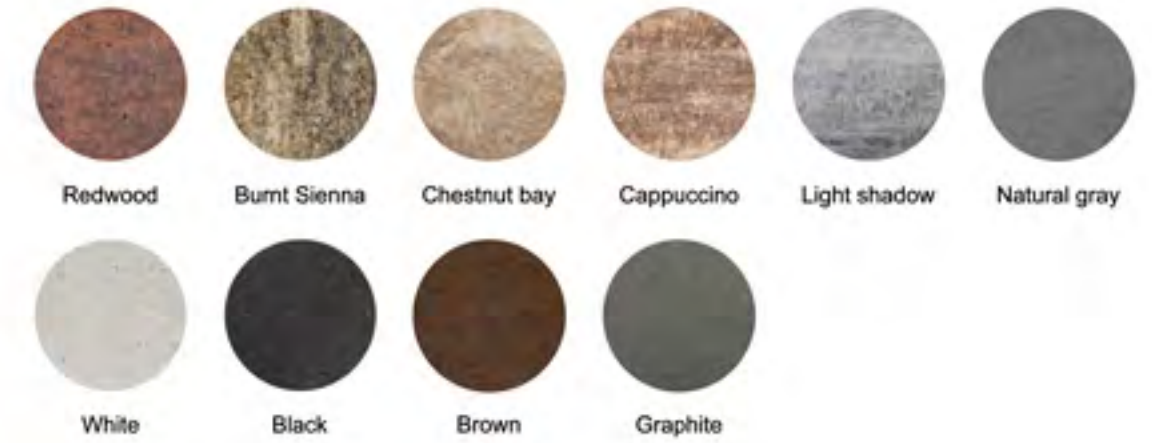

14 x 8 x 2 3/8 inches
348 x 208 x 60 mm



7 x 8 x 2 3/8 inches
173 x 208 x 60 mm



7 x 4 x 2 3/8 inches
173 x 103 x 60 mm

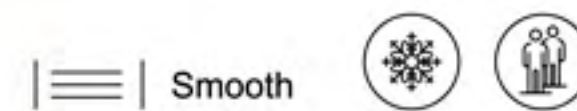



HOLLAND LUX

Holland lux



The modern brick road is paved with the lasting, trendy, and orderly aesthetic of the Holland Lux paver. With its interlocking concrete pavers, this traditional landscape brick is given a fresh new look. It can be utilized as a decorative banding when paired with pavers that measure 60 mm. This product works well on patios, walks, driveways, and decorative bandings, and is pedestrian and vehicle friendly.



In stock



Special Order



8 x 4 x 2 3/8 inches
198 x 98 x 60 mm



Smooth





ORANGE PAVERS RETAINING WALLS

*exclusive technology

Retaining walls

Retaining walls are multi-functional partitions that can define and beautify any outdoor space when thoughtfully designed. Garden beds, sitting areas, privacy shields, and more, can all be enhanced with the use of custom pavers.

The innovative Orange Pavers retaining wall is a gravity-reinforced wall system that can be installed as a garden wall to an infinite number of wall heights without the use of pins or clamps.

Orange Pavers' innovative interlocking features enable a wide range of installation patterns and radiuses, decreasing the number of failed cuts to reduce waste.





CASCADE

Base block
Dimensions: 18 x 12 x 4 inches



18" Wall block
Dimensions: 18 x 12 x 8 inches
Available in: 4/ 6/ 8 inches heights



9" Wall block
Dimensions: 9 x 8 x 8 inches
Available in: 4/ 6/ 8 inches heights



Corner block
Dimensions: 18 x 8 x 8 inches
Available in: 4/ 6/ 8 inches heights



In stock



Light shadow



Chestnut bay

Special Order



Redwood



Burnt Sienna



Cappuccino



Brown



Graphite



White



Black

Smooth





Cascade in Grey



CMU Blocks



Architectural Blocks

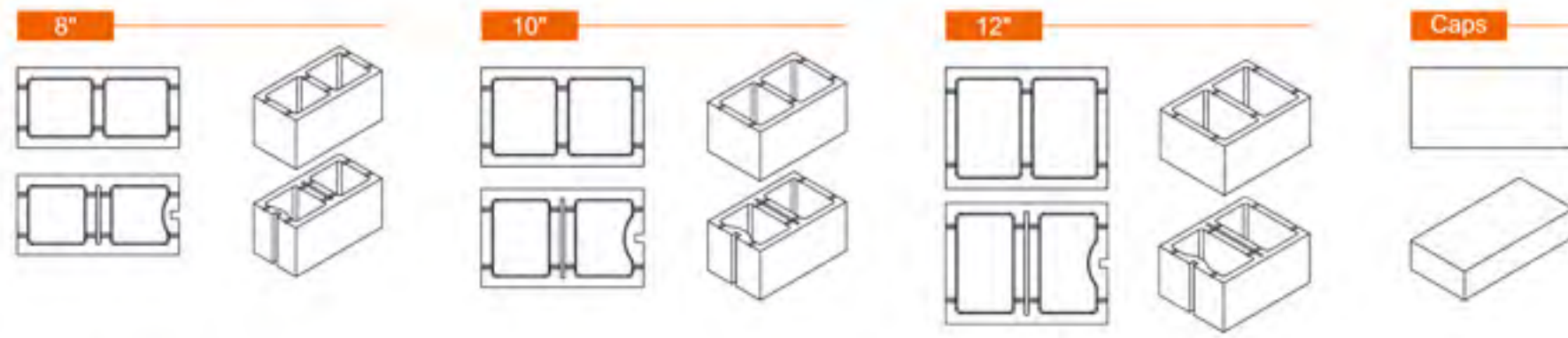

CMU Block (Smooth Surface)

Dimensions (W-H-L)	Actual size (W-H-L)	Total PSI	Total Block per pallet	Color
8" x 8" x 16"	7 1/4" x 7 3/4" x 15 1/2"	2500	108	yes
10" x 8" x 16"	9 1/4" x 7 3/4" x 15 1/2"	2500	90	yes
12" x 8" x 16"	11 1/4" x 7 3/4" x 15 1/2"	2500	72	yes

Caps (Smooth Surface)

Dimensions (W-H-L)	Actual size (W-H-L)	Total PSI	Total Block per pallet	Color
8" x 4" x 16"	7 1/4" x 3 3/4" x 15 1/2"	3500	108	yes



Agat



Carbon



Onyx

Orange Pavers it's about uniqueness. We will make any colormix on an individual order

Smooth



Durability



Perfect height



Multi color



Quality



Certified product

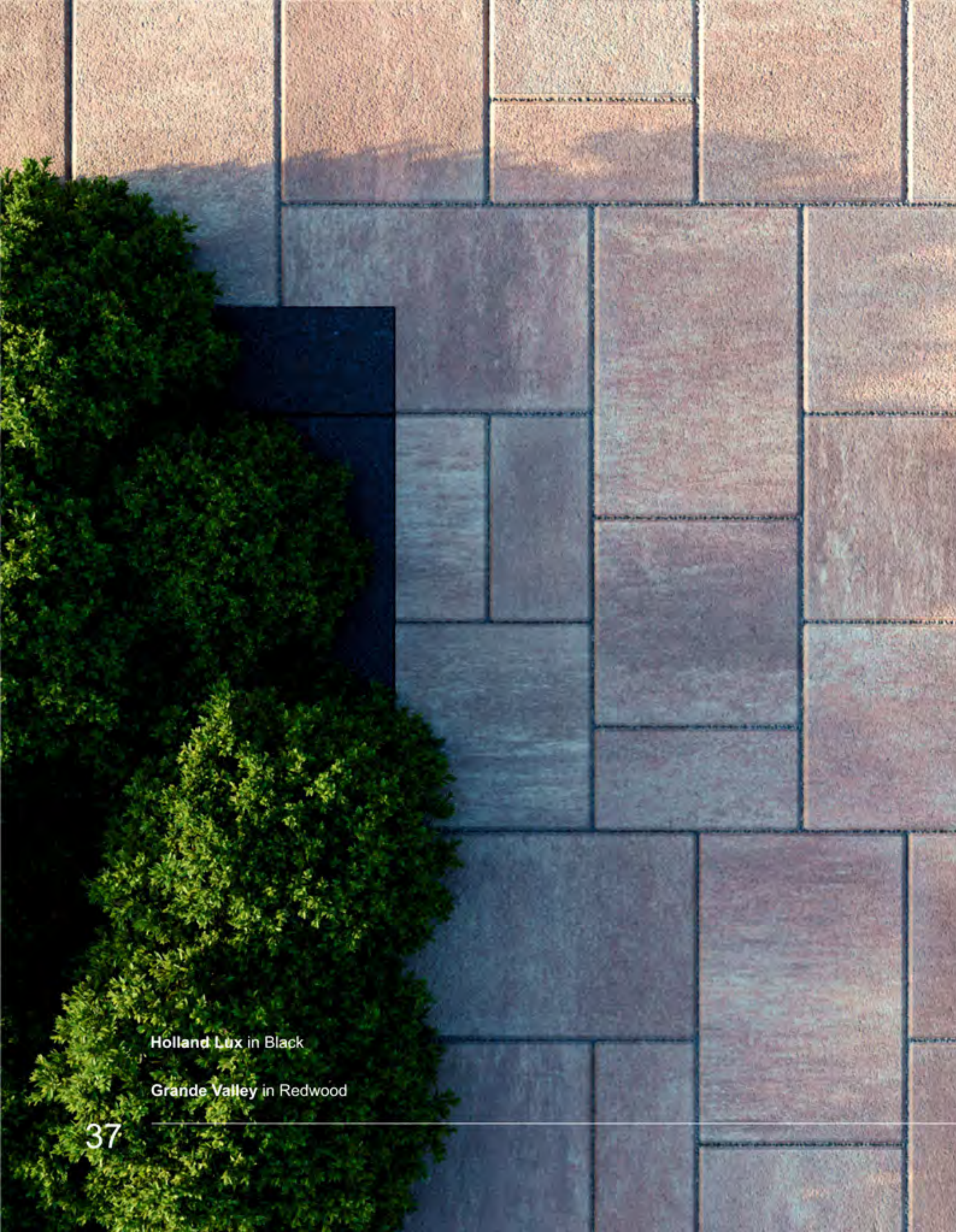

Holland Lux in Black

Grande Valley in Redwood

Choose your favorite colormix

There is nothing we love more than natural hues. We carefully considered our color selection so that all of your favorites would show up in other collections, allowing you to mix, match, and contrast as you choose. We take great pride in the distinctive color combinations we use to create each product.

We are proud of our unique shades of color mix, where each product is unique.

Here are some **Do's** and **Don'ts** when selecting color choices.

Do

Choose color to highlight your home's architectural features and accents.

Match colors to the current landscape palette. Before committing, lay out your final options. You will have a better understanding of the outcome by viewing your color choices lying flat.

Book a free color consultation with an expert guide.

Don't

Don't commit to any color without viewing it in natural light.

Don't combine more than three core colors (with the exception of wood and stone).

Hot tip!

To create consistency and a pleasing contrast, choose colors that complement the existing furniture or accents in your space.

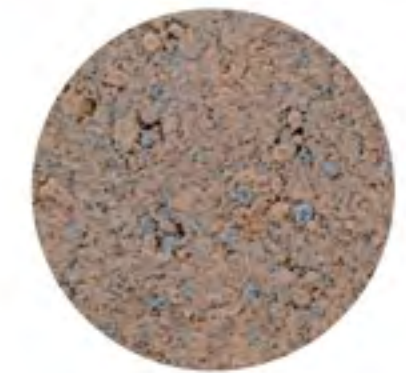

Product details

PAVERS & SLABS

Collection	Dimensions (Inch)	Chamfer	Spacer	Surface	Total Weight 1 Pallet (Pounds)	Pieces (1Row)	Pieces (1 Pallet)	Total Area 1 Pallet (Sq/ Ft)
Bohemian Buffalo	14 x 8 x 2 3/8"	-	-	Smooth	3,995	10	90	120
	7 x 8 x 2 3/8"					12	108	
	7 x 4 x 2 3/8"					6	56	
Lunar Path	24 x 6 x 2 3/8"	+	+	Smooth	3,747	14	140	135
	24 x 6 x 2 3/8"			Wooden				
Holland Lux	8 x 4 x 2 3/8"	+	+	Smooth	3,667	66	660	138
Grande Valley	16 x 16 x 2 3/8"	+	+	Smooth	4,177	9	90	153
Akoya	12 x 12 x 2 3/8"	+	+	Smooth	4,357	16	160	153
	8 x 8 x 2 3/8"					36	360	
	12 x 8 x 2 3/8"					24	240	
Arona	20 x 13 x 2 3/8"	-	+	Smooth/ Textured	3,911	3	27	116
	13 x 13 x 2 3/8"					4	36	
	7 x 13 x 2 3/8"					4	36	
Flint Stone	9 x 6 x 2 3/8"	+	+	Smooth	3,537	35	350	125
	6 x 6 x 2 3/8"					49	490	

RETAINING WALLS

Collection	Dimensions (Inch)	Surface	Pieces (1 Row)	Pieces (1 Pallet)
Cascade				
Base block	18 x 12 x 4"	Smooth	8	40
Wall block	18 x 12 x 8"		8	40
	9 x 8 x 8"		16	80
Corner block	18 x 8 x 8"		8	40

*available in: 4 /6 /8 inches heights

Pallet Overview

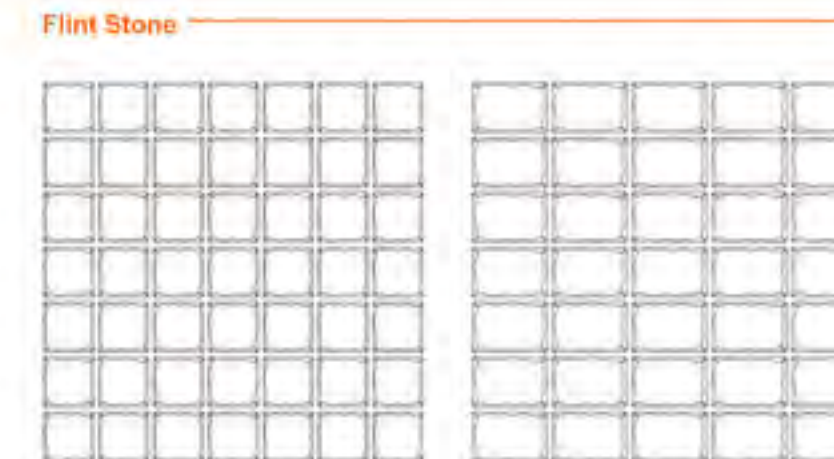
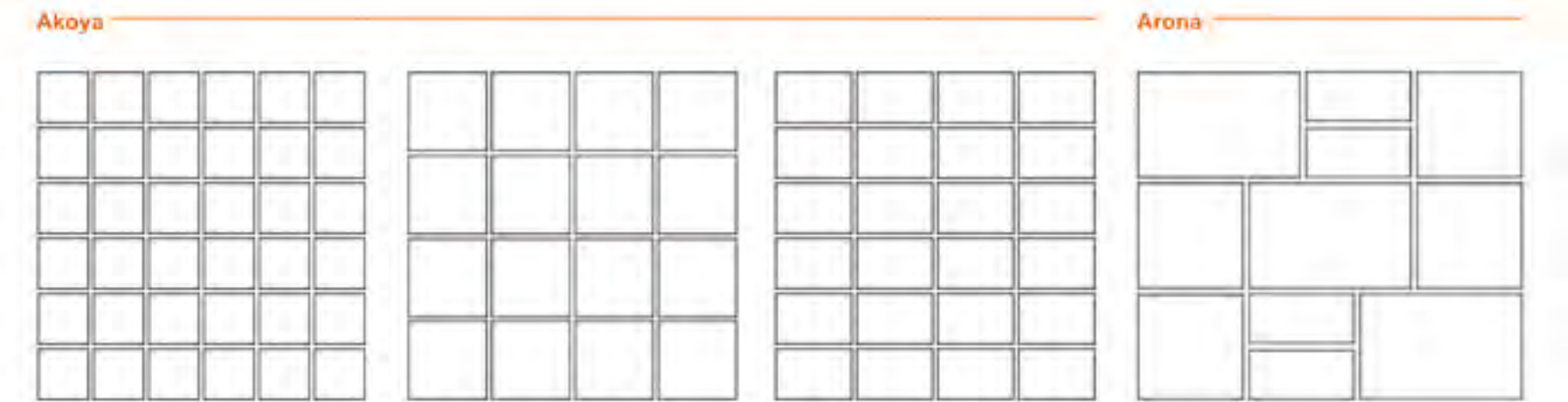
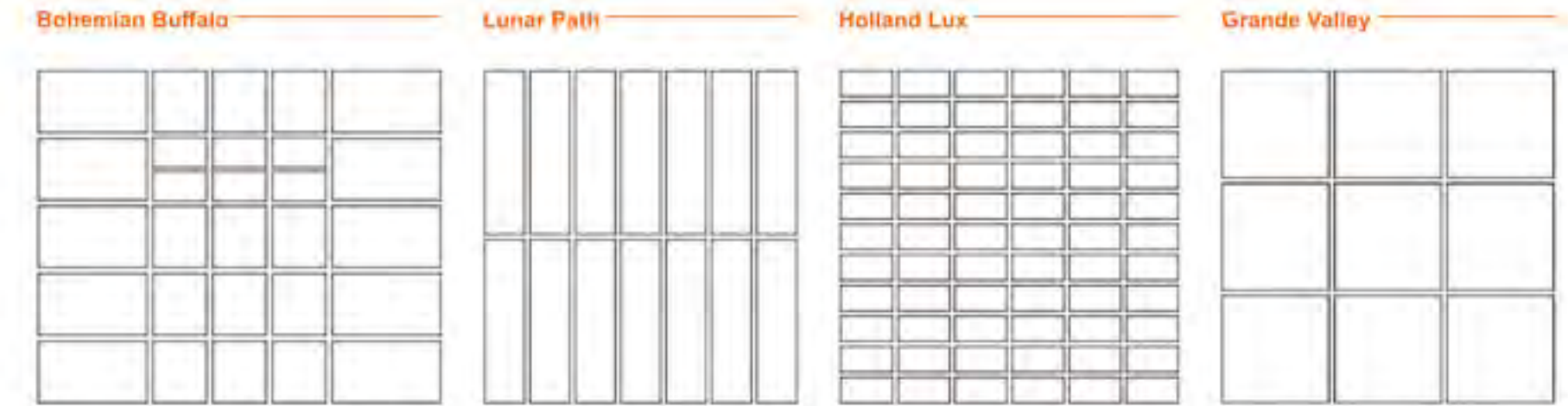







Compactor and snow removal equipment

Pavers with an embossed surface (high and low points) are more susceptible to scuff marks from vibratory plate compactors used in most concrete paver installations. Orange Pavers recommends the use of a urethane mat between the plate and the paver surface during compacting. Contact your equipment supplier for more information about accessories for this purpose. Also, snow removal equipment should have the proper spacing, bumpers, and rubber blade guards to protect the surface of the pavers.

Pavers that last a lifetime

Paver foundation

With over 25 years of experience, we use the best world technology and the most advanced equipment. The Orange Pavers stones can withstand any type of climate, making them perfect for any type of landscape.

-  De-icing salt
-  Resistant permeable
-  Eco-friendly
-  Durability
-  Detailed texture
-  Quality

A standard of care

High-quality concrete products require the same maintenance as any other product that is exposed to the environment 365 days a year. Similar to cleaning patio furniture, a car's chrome, plastic, or paint, etc., very gentle cleaning with detergents, water, and product-specific chemicals is required to increase their presence and appeal. For further defense against acid rain, stains, and the worst of nature, protective coatings of every kind – high, moderate, and low sheen, pigmented or tinted, penetrating or film forming – are available. Take care of your investments to receive the maximum return on your money, and they will take care of you.

Polymeric haze

Polymeric haze from the use of polymeric joint sand may appear on your concrete products if the sand was not properly removed from the surface of the paver. This does not, in any way, affect the integrity of the product or your installation. The hazing will weather away naturally with time and rain, or it can be removed with a specialized cleaner. For directions and suggestions, you are advised to get in touch with your contractor or the supplier of the polymeric sand.

Efflorescence

This warranty does not apply to efflorescence. Efflorescence is a natural occurring process in all concrete products which sometimes appears in the form of a white powdery film on the pavement surface. Efflorescence is more perceivable in darker colors such as Onyx Black and Chocolate Brown as there is a higher level of contrast than with other blended colors. It does not, in any way, compromise the functionality or the structural integrity of the product.

Color

Each color option is comprised up of several lighter and darker tones. To allow for a variety of tones, veining, and textures from one stone to another, natural elements like granite are included in the mix. Orange Pavers cannot guarantee exact color matching to printed versions of its color swatches due to the inherent nature of printed literature and current digital media. The color samples shown are approximate representations of our standard colors, and actual product colors may differ. Therefore, the final color choice should be taken from the product that is in stock at your local retailer.

Construction residue

A by-product of cutting with a saw is residue-filled water or concrete dust. Residue filled water or re-hydrated dust can cling to the surface and leave a concrete stain. It is recommended to wash and remove the water or concrete dust from the surface of the pavers before it dries. Construction residue can also happen through soil disturbance or environmental elements.

Paving patterns

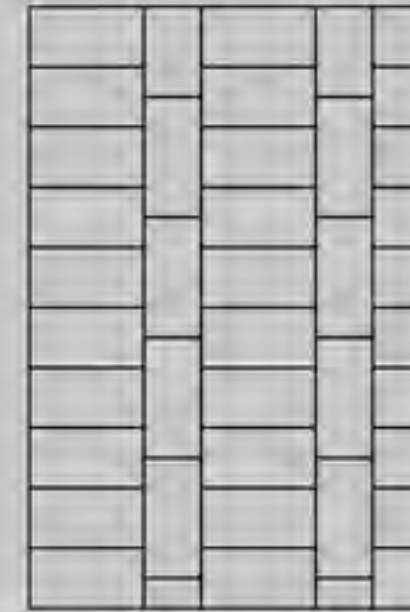

Running

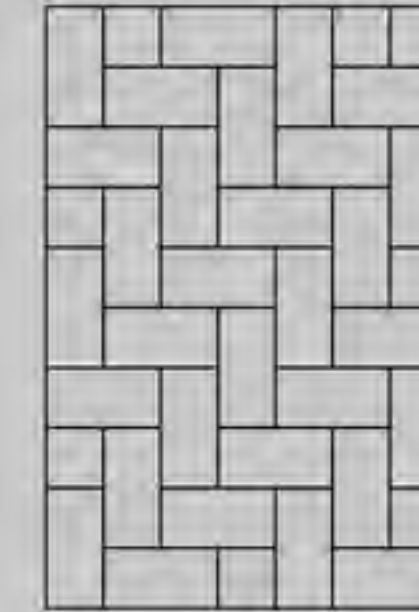

Herringbone 90°

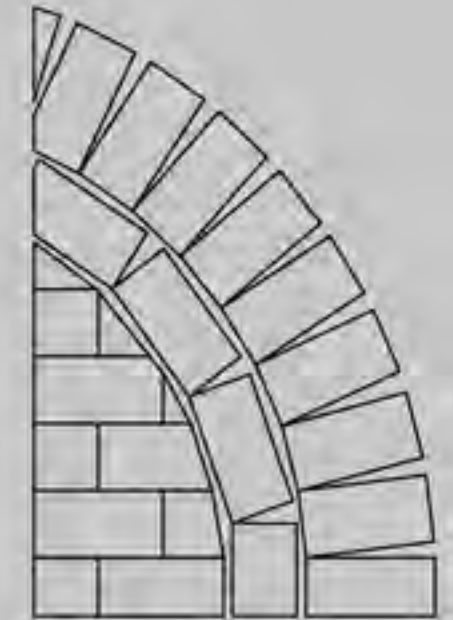

Soldier header

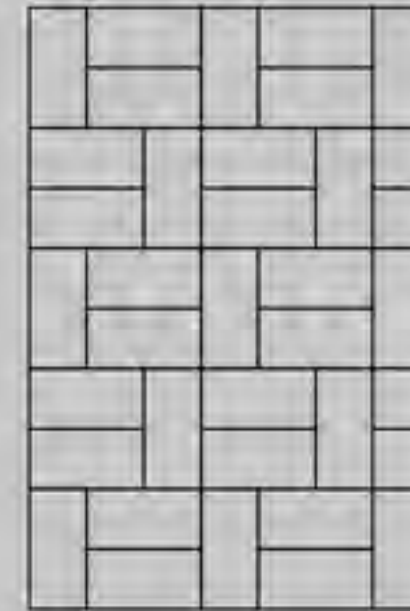

Parquet

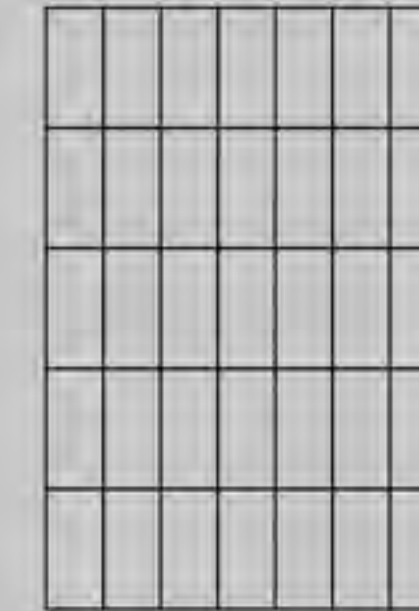

Seam to seam

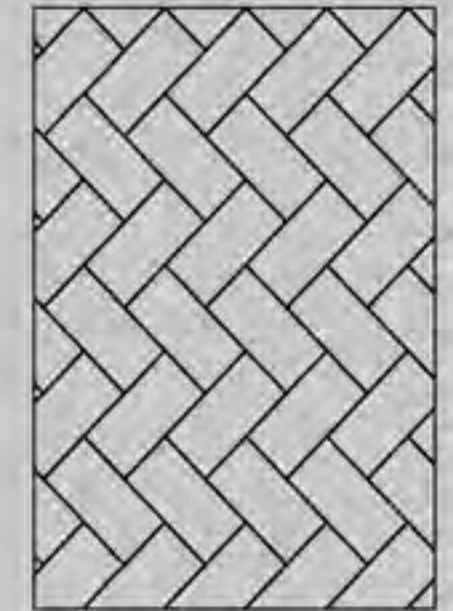

Herringbone 45°

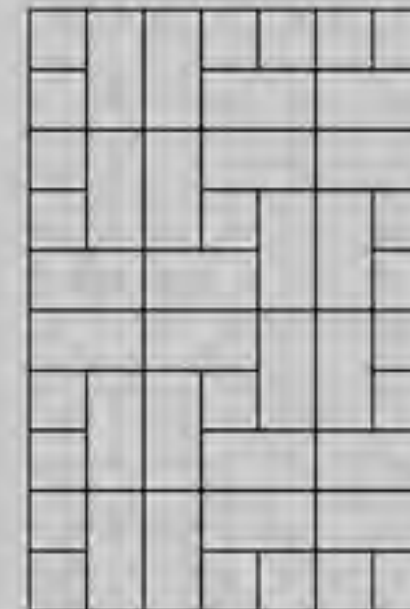

Boxed basketweave

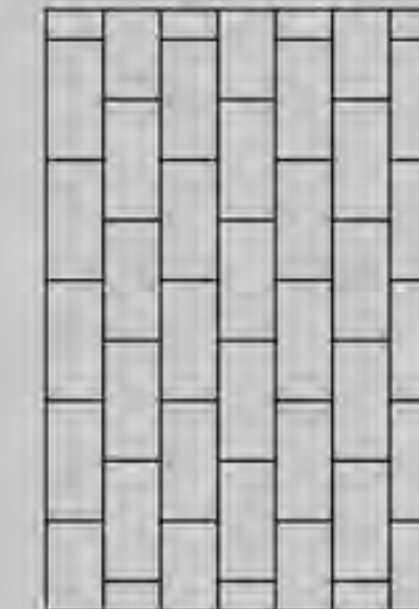

Stretcher bond

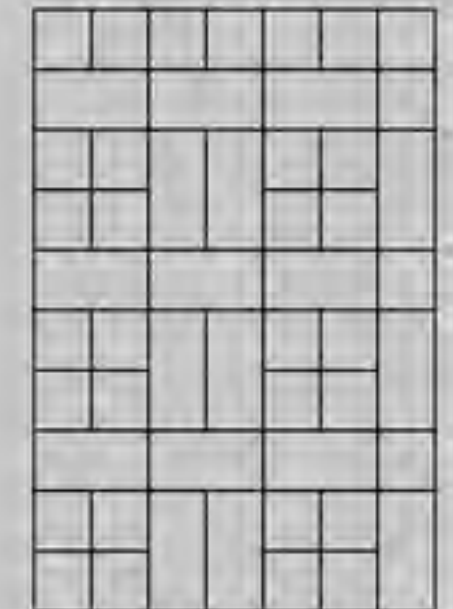

Mixture of sizes

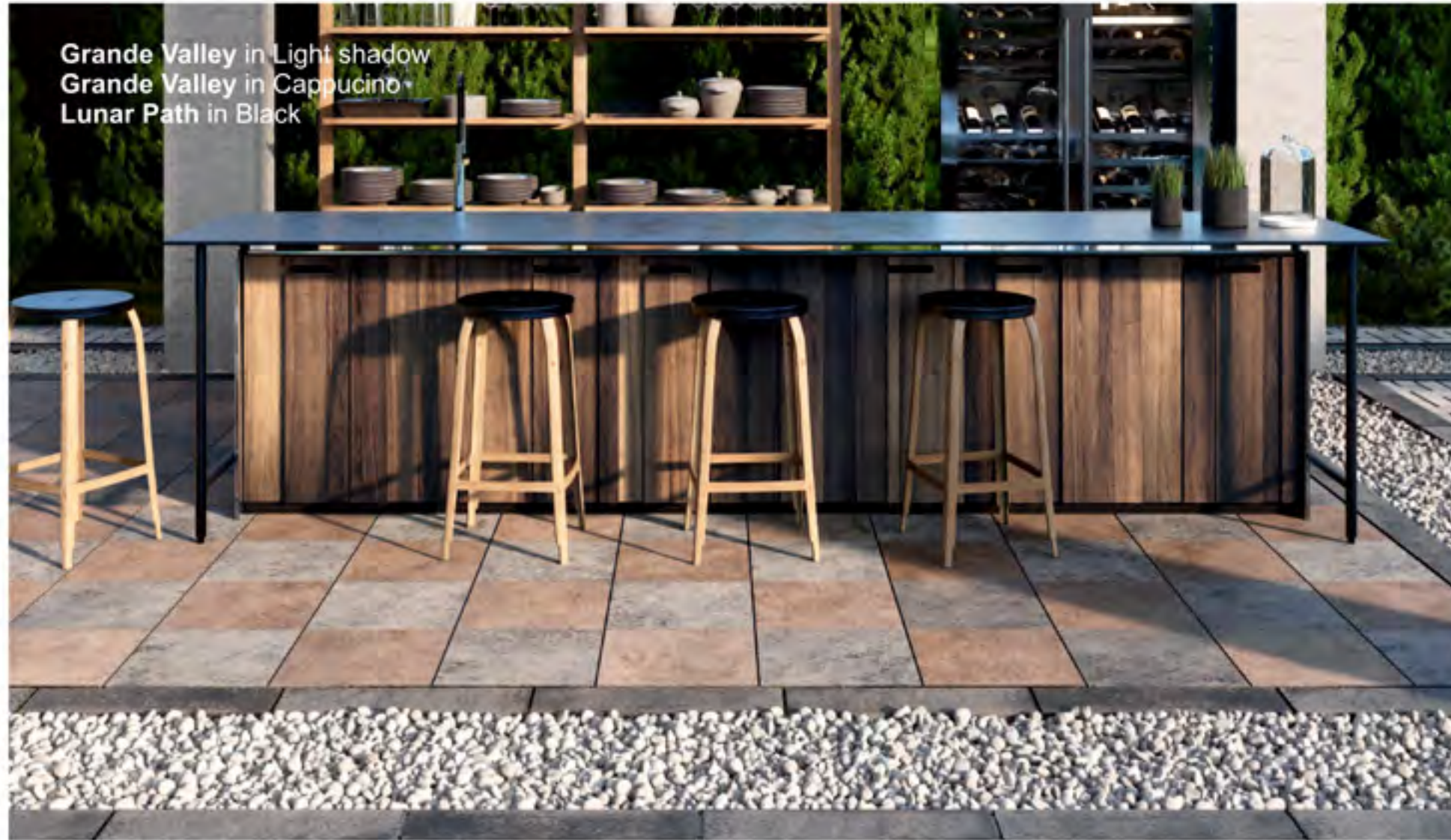

Grande Valley in Light shadow
Grande Valley in Cappuccino
Lunar Path in Black



Bohemian buffalo in Light shadow



Grande Valley in White



Holland Lux in Light shadow

Commercial & Industrial

For high-quality, long-lasting pavers, trust the experts!
Across a variety of scales, we strive to achieve the ideal harmony between organic colors and realistic textures.
Our commercial-grade pavements are designed to protect the pavement's lifespan from rigorous application and harsh weather conditions.

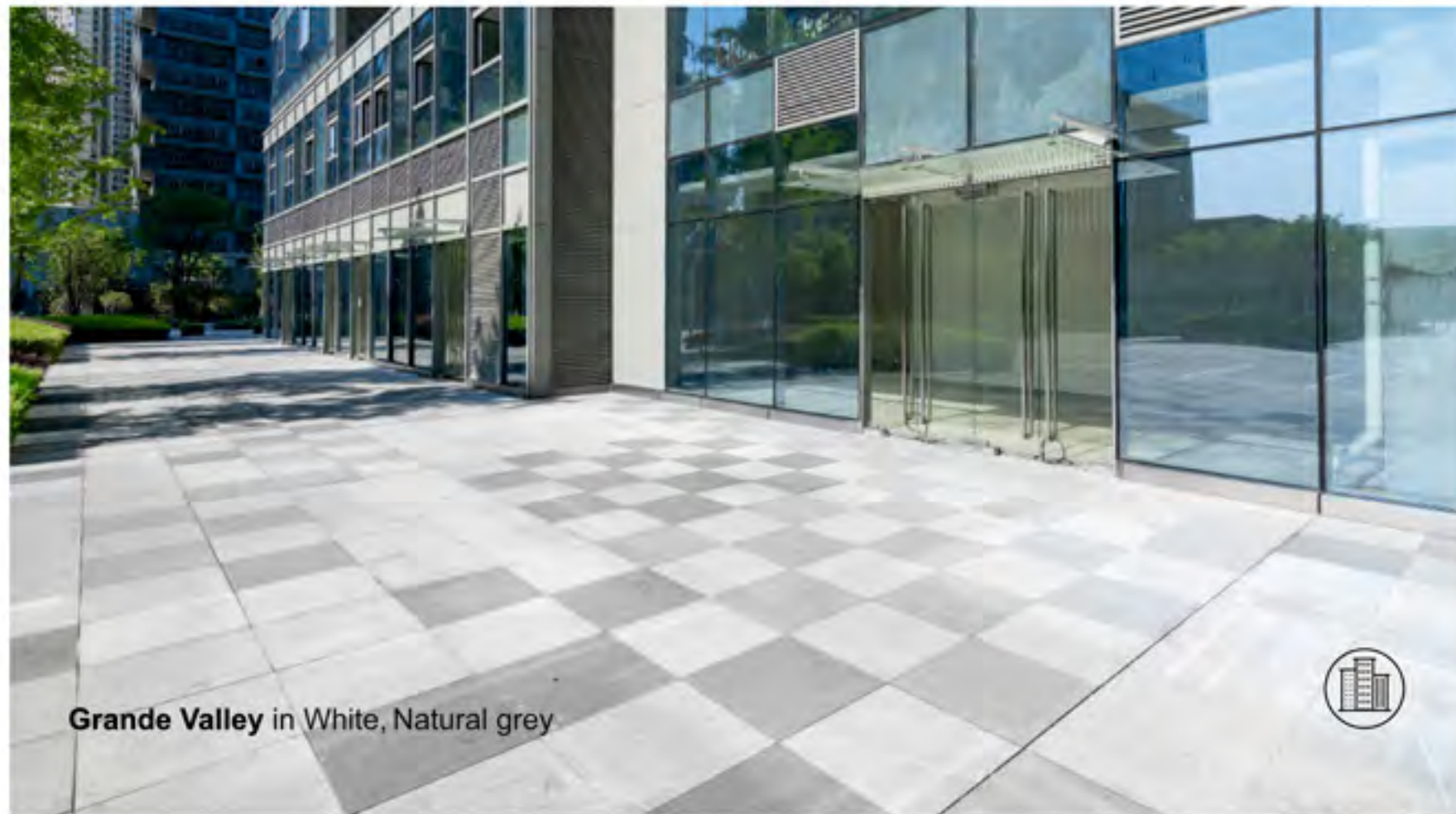



**ORANGE
PAVERS**

Your vision. Our Pavers



orangepavers.com
570.324.4404

Version 1.1